

# BOOMX-D

2.4G Digital Wireless Microphone

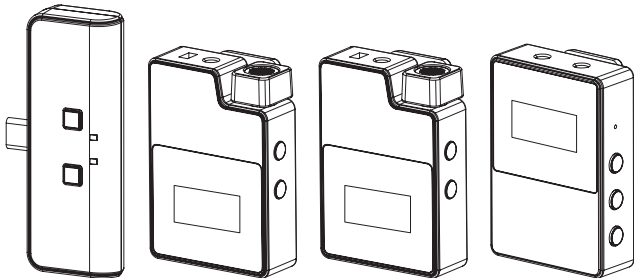

**User Manual**



## FCC statement

This device complies with Part 15 of the FCC rules. Operation is subject to the following two conditions: 1) this device may not cause harmful interference, and 2) this device must accept any interference received, including interference that may cause undesired operation.

Note: This equipment has been tested and found to comply with the limits for a Class B digital device, pursuant to part 15 of the FCC Rules. These limits are designed to provide reasonable protection against harmful interference in a residential installation. This equipment generates uses and can radiate radio frequency energy and, if not installed and used in accordance with the instructions, may cause harmful interference to radio communications. However, there is no guarantee that interference will not occur in particular installation. If this equipment does cause harmful interference to radio or television reception, which can be determined by turning the equipment off and on, the user is encouraged to try to correct the interference by one or more of the following measures:

- Reorient or relocate the receiving antenna.
- Increase the separation between the equipment and receiver.
- Connect the equipment into an outlet on a circuit different from that to which the receiver is connected.
- Consult the dealer or an experienced radio/TV technician for help.

Changes or modifications not expressly approved by the party responsible for compliance could void the user's authority to operate the equipment.

### FCC Radiation Exposure Statement

This device complies with FCC RF radiation exposure limits set forth for an uncontrolled environment. This transmitter must not be co-located or operating in conjunction with any other antenna or transmitter.

# IC

This device complies with Industry Canada's licence-exempt RSSs. Operation is subject to the following two conditions:

- (1) This device may not cause interference; and
- (2) This device must accept any interference, including interference that may cause undesired operation of the device.

Le présent appareil est conforme aux CNR d'Industrie Canada applicables aux appareils radio exempts de licence. L'exploitation est autorisée aux deux conditions suivantes:

- (1) l'appareil ne doit pas produire de brouillage.
- (2) l'utilisateur de l'appareil doit accepter tout brouillage radioélectrique subi, même si le brouillage est susceptible d'en compromettre le fonctionnement.

IC: 27232-BOOMXD

Model#BOOMX-D

PMN: 2.4G Digital 1-Trigger-2 Wireless Microphone

FVIN: 053 tx = 1.2.4

## Foreword

Thanks for purchasing COMICA BoomX-D

## Main Features

- 2.4G Dual-channel Wireless Microphone, Global Free Frequency
- 48kHz/16bit Record, CD-level Sound Quality
- Digital/Analog Outputs, Universal for Camera/ Smartphone/PC
- Support Gain Control, One-click Muting and Denoise
- Intuitive Power, Audio Dynamic Monitor and Other Display Functions
- Real-time Monitor, Mono/Stereo/Safety Mode Switch
- Internal and External MIC Two Input Modes
- Low Latency<20ms, Working Range up to 200m(Open Area)
- Designed with Multi-functional Belt Clip and Compact

## Notice

- ⚠ Due to 2.4G wireless characteristics, please keep face to face when use it, and don't turn your back to the receiver, otherwise it is easy to generate breakpoints, which is a normal phenomenon
- ⚠ Don't block the antenna position to avoid any poor signal generated
- ⚠ This product belongs to high-precision instruments, please avoid falling, collision or pounding
- ⚠ Do not use this equipment in the vicinity of heat source or interference source, such as radiator, oven, refrigerator or air conditioner
- ⚠ If the pick-up distance is close or when used outdoors, please put on the wind muff to prevent sound burst or reduce wind noise
- ⚠ Do not use the equipment in rain or in a damp environment to avoid short-circuit danger

Please keep face to face when use it, and don't turn your back to the receiver, otherwise it is easy to generate breakpoints.

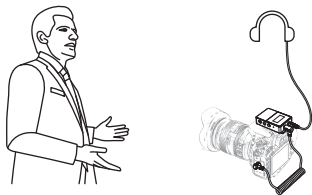

Face to receiver (correct)

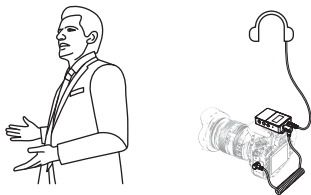

Back to receiver (incorrect)

Don't block the antenna position to avoid any poor signal generated.

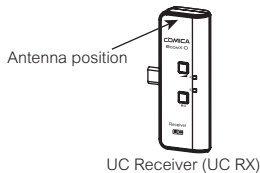
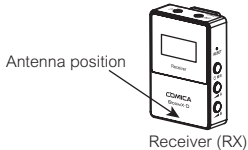
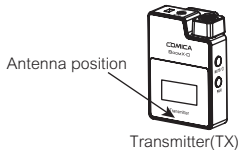

# Packing List

## Main Parts:



Transmitter(TX)



Receiver (RX)



UC Receiver (UC RX)

## Multiple Selections:



D1 = TX + RX  
(Black/White)



D2 = TX + TX + RX  
(Black/White)



UC1 = TX + UC RX



UC2 = TX + TX + UC RX



## Accessories:

- ① 3.5mm Mic Audio Input Cable
- ② Wind Muff
- ③ 3.5mm TRS-TRRS Audio Output Cable
- ④ 3.5mm TRS-TRS Audio Output Cable
- ⑤ Charging Cable
- ⑥ 3 in 1 Charging/Output Cable (The orange cable can be used for charging and data transmitting; the black cables can only be used for charging.)
- ⑦ Carry Case
- ⑧ User Manual
- ⑨ Warranty Card



The accessories of each combination include:

D1= ① + ② + ③ + ④ + ⑥ + ⑦ + ⑧ + ⑨

D2= ①x2 + ②x2 + ③ + ④ + ⑥ + ⑦ + ⑧ + ⑨

UC1= ① + ② + ⑤ + ⑧ + ⑨

UC2= ①x2 + ②x2 + ⑥ + ⑧ + ⑨

## Components and Instruction

### Transmitter (TX)

1. External Mic Locking Buckle
2. 3.5mm TRS Port of External Mic
3. Internal Mic
4. Power/Muting/Reset Button
5. Pair/Denoise Button
6. Belt Clip
7. USB-C Charging Port

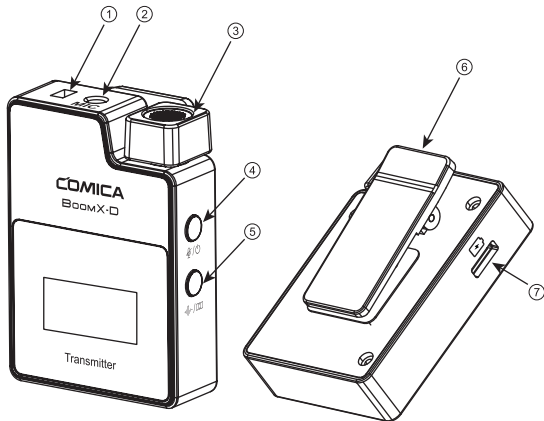

## Receiver (RX)

1. 3.5mm TRS/TRRS Monitoring Port
2. 3.5mm TRS Audio Output Port
3. Power/Reset/Mode Switch Button
4. A/B Channel Output Gain Control/Pair Button
5. Belt Clip
6. USB-C Charging/Output Port

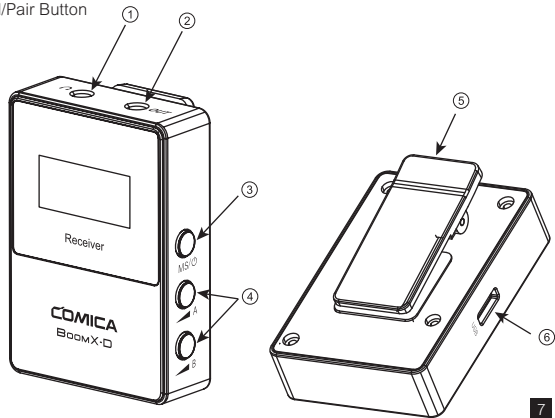

## UC Receiver (UC RX)

1. USB-C Connector
2. Output Volume Adjustment Button
3. Group A Working Status Indicator
4. Group B Working Status Indicator
5. M/S Adjustment Button
6. 3.5mm TRS/TRRS Monitoring Port

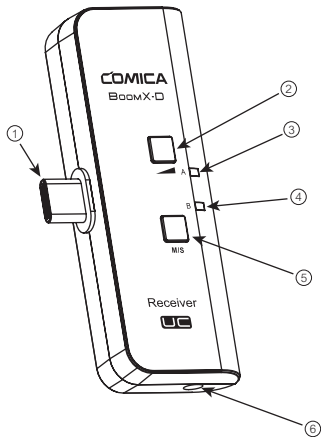

# Screen Display and Function

## Transmitter (TX)

### 1. Screen Display Instruction:

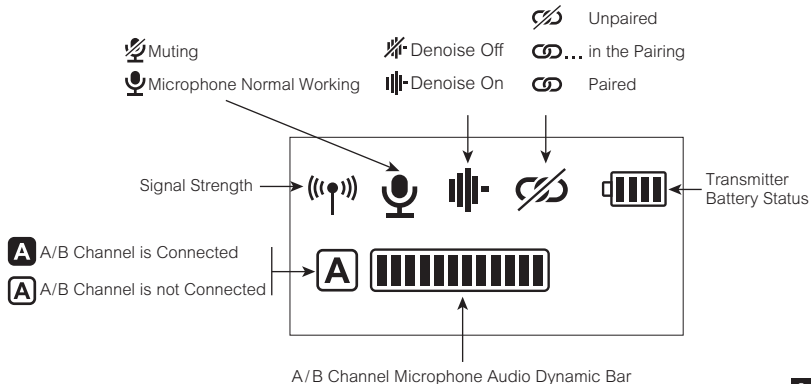

## 2.Function Introduction:

### 2.1. Power/Muting/Reset Button

Long press for On/Off; When the device is crash or unable to be turned on, long press for ten seconds to reset; Short press for muting switch.



### 2.2. Pair/Denoise Button

Long press for pairing with receiver; Short press to denoise.



### 2.3. USB-C Charging Port

Connect the transmitter with the power through the USB A-USB C charging cable to charge.

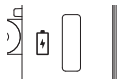

## 2.4. 3.5mm TRS Microphone Port

Insert the 3.5mm TRS microphone input cable, and you can use the external lavalier microphone for recording. At this time, the internal microphone of this device is turned off.



All the function adjustments are only available when the screen is on, and if the screen is dimmed, press any button to light up the screen and then adjust again.

# Receiver (RX)

## 1. Screen Display Instruction:

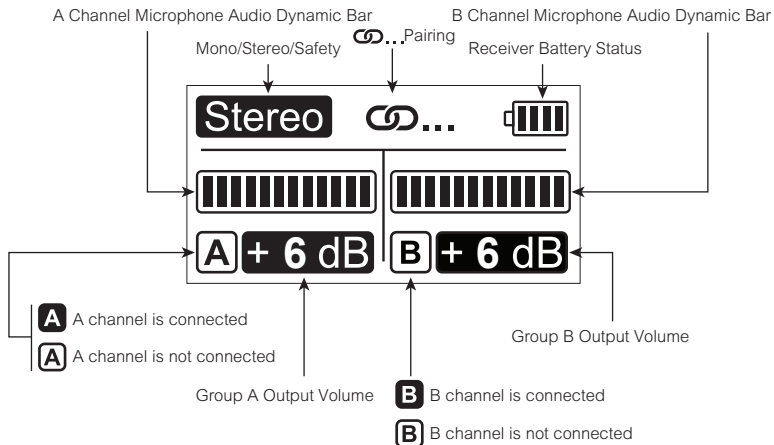



## 2.Function Introduction:

### 2.1. Power/Reset/Mode Switch Button

Long press for On/Off; When the device is crash or unable to be turned on, long press for ten seconds to reset; Short press to switch Mono/Stereo/Safety mode.

In Mono mode, it outputs the mixed audio of A&B channel;

In Stereo mode, it outputs separated audio of A/B channel;

In Safety mode, it outputs the mixed audio of A&B channel, the audio in channel A is normal audio, and in channel B, the safe audio reduced with -6dB based on the normal audio.



### 2.2. A/B Channel Output Volume Control/Pair Button

Short press to cyclically adjust the A/B channel volume; When it is not paired, long press the two buttons at the same time to pair.



### 2.3. USB-C Charging/Output Port

Connect the receiver with the power/USB devices through the 3-in-1 charging/output cable to charge/output audio.



### 2.4. 3.5mm TRS Audio Output Port

Connect with mobile phone through the 3.5mm TRS-TRRS audio cable; Connect with camera through the 3.5mm TRS-TRS audio cable.



### 2.5. 3.5mm TRS/TRRS Monitoring Port

Insert headphone to monitor.



 All the function adjustments are only available when the screen is on, and if the screen is dimmed, press any button to light up the screen and then adjust again.

## UC Receiver (UC RX)

### Function Introduction:

#### 1. USB-C Plug

Insert into the USB-C port of phone to use.



#### 2. Output Volume Adjustment Button

Short press to cyclically adjust the Volume, and A/B channel is synchronized.



#### 3. M/S Button

Short press for Mono/Stereo switch. Please attention that it can not realize STEREO function when in single-channel mode.



#### 4. A/B Working Status Indicator

The indicator blinks green when unpaired; When paired, it shows blue in mono mode and green in stereo mode.

A

B

#### 5. 3.5mm TRS/TRRS Monitoring Port

Insert headphone to monitor.



 BoomX-D UC do not support Safety mode.

## Installation and Usage

### Transmitter(TX)

1. Use the internal/external mic according to your need.

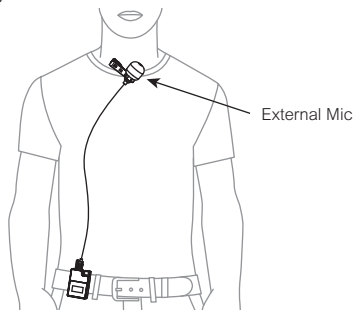
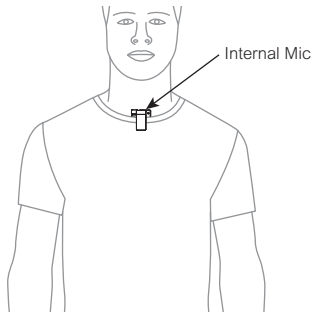

1. For better concealment during use, it is recommended that the belt clip is fixed and used outwards.
2. When using an external microphone, the internal microphone is automatically turned off.

# Receiver (RX)

## 1. Analog Output:

When used with a camera, connect it through the 3.5mm TRS-TRS audio cable; When used with a mobile phone or computer, connect it through the 3.5mm TRS-TTRS audio cable and related OTG audio cable/adaptor to monitor according to your needs (please purchase the relevant audio cable/adaptor by yourself)

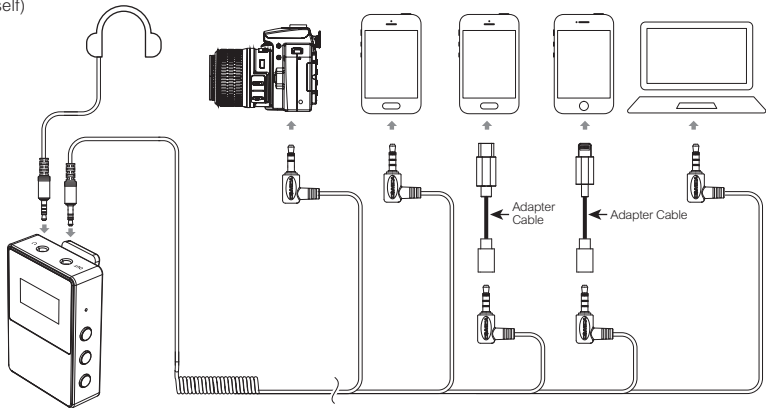

## 2. Digital Output

Connect the receiver with the USB interface devices through the corresponding audio cable and audio adapter, then insert the headphone to monitor according to your need

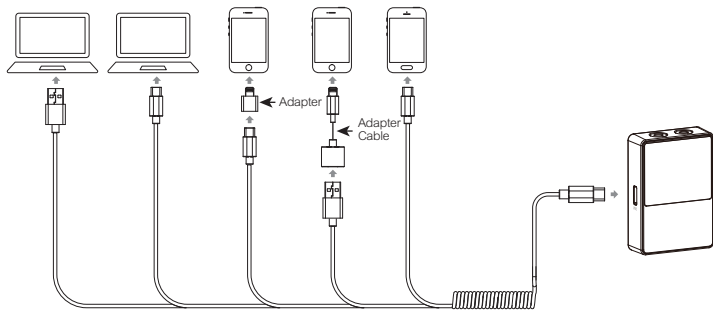

BoomX-D is equipped with a USB C-USB A audio cable(the orange cable of the 3 in 1 charging/output cable), please purchase other audio cable and audio adapter by yourself

## UC Receiver (UC RX)

Insert the UC receiver (UC RX) into the USB-C port of the phone; Insert the headphone into the 3.5mm TRS/TRRS monitoring port for monitoring.

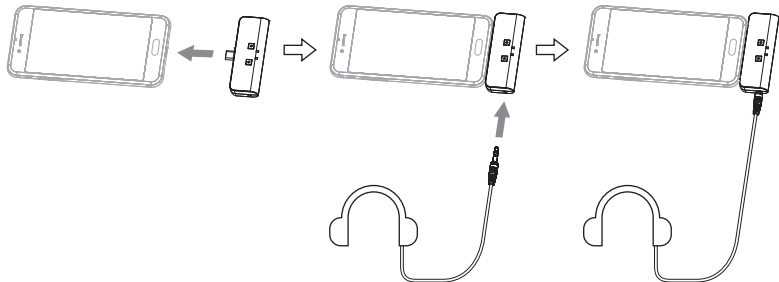



## Pairing Method

(All have been paired at the factory. If you need to re-pair, please follow the description)



### BoomX-D:

Turn on the transmitter and receiver within one meter; Long press pairing buttons of TX and RX to pair, and the pairing status on screen shows ... The A/B character shows **A**/**B** when A/B channel is paired.

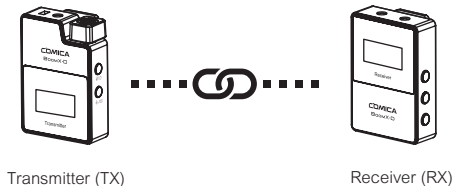
The transmitter (TX) is pairing with the receiver (RX)



## BoomX-D UC:

Connect the receiver with your device to pair, and the indicators blink blue. Long press the pairing button of the transmitter to pair, and the pairing status on screen shows ...  
When paired, the screen shows , and the indicators on RX show blue(Mono mode)/green(Stereo mode).

The transmitter (TX) is pairing with UC Receiver (UC RX)

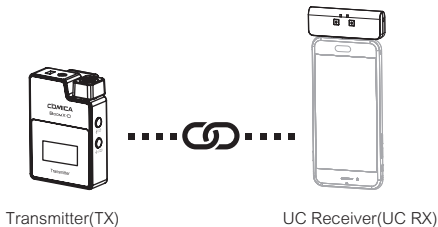

- 1.The TX/RX can only enter the pairing state when they are not paired.
- 2.When a transmitter is not paired, the paired transmitter needs to be turned off first. Refer to the above steps to pair the unpaired transmitter with the receiver. After pairing, turn on the paired transmitter.

## Specification

### Transmitter (TX)

Wireless Type	2.4GHz
Antenna	Ceramic Antenna
Transmitting Power	+10dBm
Microphone Sensitivity	-32dB $\pm$ 2dB
Polar Pattern	Omnidirectional
Frequency Response	80Hz~20kHz
S/N	70dB SPL(A-weighted,as per IEC651)
Equivalent Noise	24dB SPL(A-weighted,as per IEC651)
Maximum SPL	110dB SPL(@ 1% THD)
Dynamic Range	86dB SPL(A-weighted,as per IEC651)
Sound Delay	<20ms
External Mic Input Port	3.5mm TRS
Battery	Li-ion Battery 330mAh 3.7V
Operating Time	15 Hours
Net Weight	29g
Dimension	39 X22 x 55mm
Working Temperature	0 $^{\circ}$ C ~50 $^{\circ}$ C
Storage Temperature	-20 $^{\circ}$ C ~+60 $^{\circ}$ C

## Receiver (RX)

Wireless Type	2.4GHz
Antenna	Ceramic Antenna
Transmitting Power	+10dBm
S/N	70dB SPL(A-weighted,as per IEC651)
Equivalent Noise	24dB SPL(A-weighted,as per IEC651)
Dynamic Range	86dB SPL(A-weighted,as per IEC651)
Sound Delay	<20ms
Output Gain Range	-6dB~+6dB
Analog Output	3.5mm TRS
Digital Output	USB-C / 48kHz 16bits
Monitor Port	3.5mm TRS/TRRS
Battery	Li-ion Battery 330mAh 3.7V
Standby Time	12 Hours
Net Weight	28g
Dimension	39X22X55mm
Working Temperature	0℃~50℃
Storage Temperature	-20℃~+60℃

## UC Receiver (UC RX)

Wireless Type	2.4GHz
Antenna	Ceramic Antenna
Transmitting Power	+10dBm
Audio Output Level	1~4 Level(6dB increments per level)
S/N	70dB SPL(A-weighted,as per IEC651)
Equivalent Noise	24dB SPL(A-weighted,as per IEC651)
Dynamic Range	86dB SPL(A-weighted,as per IEC651)
Sound Delay	<20ms
Digital Output Plug	USB-C
Monitor Port	3.5mm TRS/TRRS
Net Weight	15g
Dimension	33X13X70mm
Working Temperature	0℃~50℃
Storage Temperature	-20℃~60℃



Website: [comica-audio.com](http://comica-audio.com)

Facebook: Comica Audio Tech Global

Instagram: Comica Audio

YouTube: Comica Audio

The COMICA LOGO is a trademark which is registered and owned by Commlite Technology Co.,Ltd

Email: [support@comica-audio.com](mailto:support@comica-audio.com)

# BOOMX-D

2.4G数字无线双通道麦克风

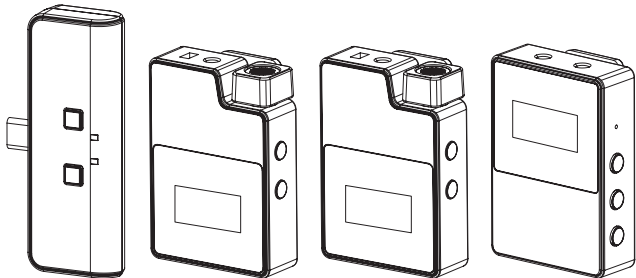

用户使用手册





## 前言

感谢您购买科唛BoomX-D

### 产品主要功能

- . 2.4G双通道无线麦克风，全球通用频段
- . 48kHz/16bit录音，超CD级音质
- . 数字/模拟双模式输出，广泛兼容相机，手机，电脑
- . 支持增益可调，一键静音及降噪
- . 可视化电量，音频动态监控等屏显功能
- . 支持实时监听，单声道/立体声/安全音轨多模式切换
- . 内置和外置MIC两种输入方式
- . 低音频延迟<20ms，传输距离稳定高达200米（空旷环境）
- . 多功能背夹设计，小巧精悍

## 注意事项

- △ 由于2.4G无线特性，使用时尽量保持面对面，避免背对的情况，否则容易产生断点，属正常现象
- △ 使用时避免任何物体遮挡天线位置，以免信号不良
- △ 本产品属于高精密仪器类产品，请避免使用时掉落、碰撞或重击
- △ 请勿将本设备放置在热源或干扰源附近使用，如散热器、烤箱
- △ 如拾音距离较近或于户外使用时，请套上麦克风防风毛，防止声音爆裂或降低风噪
- △ 不要在雨中或潮湿的环境中使用该设备，否则会有短路的危险

尽量保持面对面，避免背对的情况，否则容易产生断点

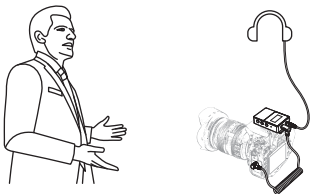

面对面（正确）

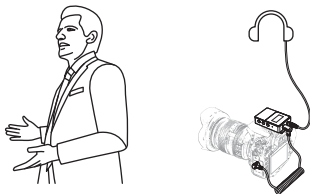

背对（错误）

使用时避免任何物体遮挡天线位置，以免信号不良

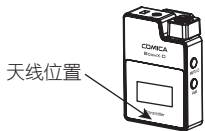

天线位置

发射器 (TX)

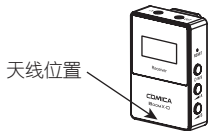

天线位置

接收器 (RX)

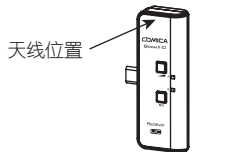

天线位置

UC接收器 (UC RX)

## 包装清单

主体:



发射器 (TX)



接收器 (RX)



UC接收器 (UC RX)

搭配选择:



D1 = TX + RX  
(黑色/白色)



D2 = TX + TX + RX  
(黑色/白色)



UC1 = TX + UC RX



UC2 = TX + TX + UC RX

## 配件:

- ① 3.5mm 麦克风输入线
- ② 防风毛
- ③ 3.5mm TRS-TRRS音频连接线
- ④ 3.5mm TRS-TRS音频连接线
- ⑤ 充电线
- ⑥ 三合一充电/输出线(其中橙色线具备充电和数据传输功能, 另外两条黑色线只具备充电功能)
- ⑦ 便携包
- ⑧ 说明书
- ⑨ 保修卡



每一个型号的配件包括:

D1= ①+②+③+④+⑥+⑦+⑧+⑨

D2= ①x2+②x2+③+④+⑥+⑦+⑧+⑨

UC1= ①+②+⑤+⑧+⑨

UC2= ①x2+②x2+⑥+⑧+⑨

## 部件介绍及说明

### 发射器 (TX)

1. 外置麦克风插头卡扣
2. 3.5mm TRS外置麦克风插孔
3. 内置麦克风
4. 电源/静音/复位按键
5. 配对/降噪按键
6. 背夹
7. USB-C充电插口

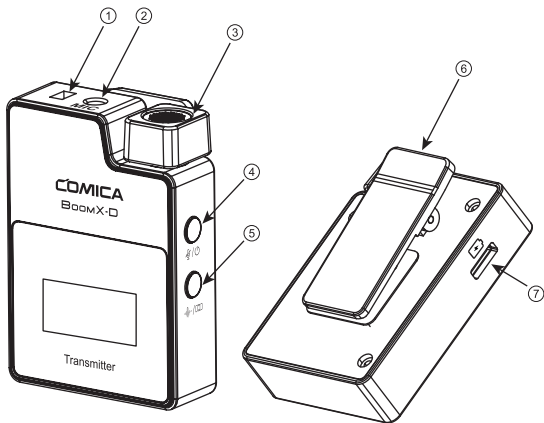

## 接收器 (RX)

1. 3.5mm TRS/TRRS耳机监听插孔
2. 3.5mm TRS音频输出插孔
3. 电源/复位/模式切换按键
4. A/B通道输出音量调节/配对按键
5. 背夹
6. USB-C充电/输出接口

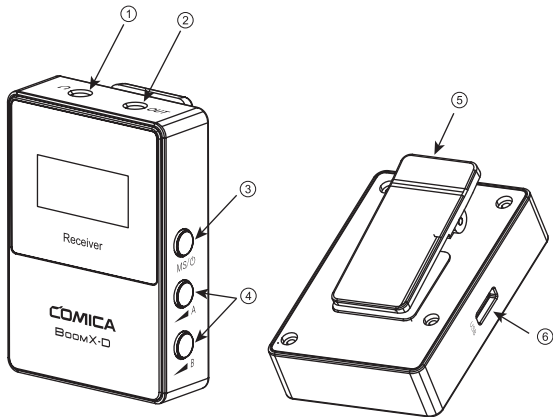

## UC接收器 (UC RX)

1. USB-C插头
2. 输出音量调节按钮
3. A通道工作状态指示灯
4. B通道工作状态指示灯
5. 单声道/立体声切换按钮
6. 3.5mm TRS/TRRS耳机监听插孔

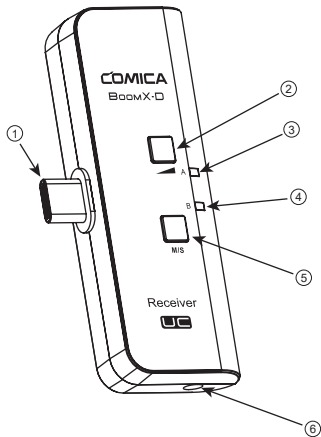



# 屏显与功能介绍

## 发射器 (TX)

### 1. 屏幕显示:

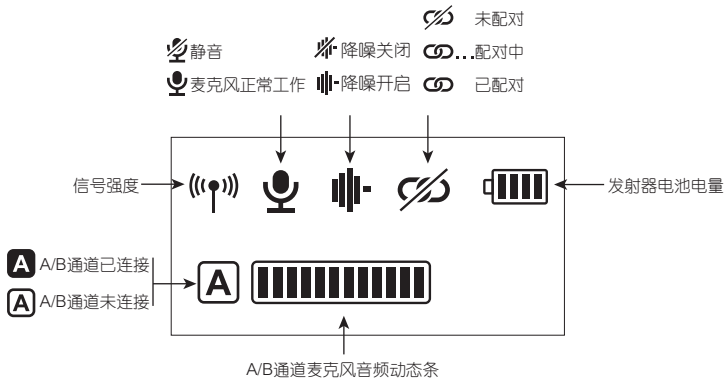

## 2.功能介绍:

### 2.1. 电源/静音/复位按键

长按开机/关机；如遇死机或无法开机等异常现象，长按十秒复位；短按进行静音切换



### 2.2. 配对/降噪按键

长按与接收器进行配对，短按降噪



### 2.3. USB-C充电插口

通过USB A-USB C充电线连接发射器与电源进行充电

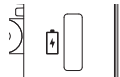

#### 2.4. 3.5mm TRS麦克风插孔

插入3.5mm TRS麦克风输入线，即可使用外置领夹麦克风进行录音，此时本机的内置麦克风被关闭



👉功能按键在屏幕亮显时才可用，若屏幕暗显，请先按任意按键点亮屏幕后再进行相关操作

# 接收器 (RX)

## 1. 屏幕显示:

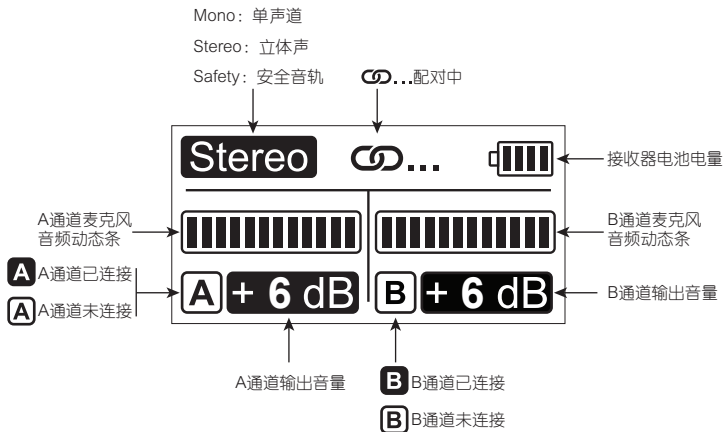

## 2.功能介绍:

### 2.1. 电源/复位/模式切换按键

长按开机/关机；如遇死机或无法开机等异常现象，长按十秒复位；短按切换单声道，立体声以及安全音轨模式。单声道模式下输出AB两通道的混合音频；立体声模式下输出AB两通道的独立音频；安全音轨模式下输出AB两通道的混合音频，A通道为正常音频，B通道为降低-6dB后的安全音频



### 2.2. A/B通道输出音量调节/配对按键

短按可循环调节A/B通道输出音量；未配对时，同时长按A/B按键进入配对状态



### 2.3. USB-C充电/输出接口

通过三合一充电/输出线连接接收器与电源可进行充电；连接接收器与USB接口的设备可进行数字输出

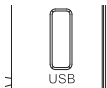

### 2.4. 3.5mm TRS音频输出插孔

通过3.5mm TRS-TRRS音频连接线与手机进行连接；通过3.5mm TRS-TRS音频连接线与相机进行连接



### 2.5. 3.5mm TRS/TRRS耳机监听插孔

插入3.5mm TRS/TRRS耳机即可监听



👉 所有功能调节需在屏幕亮显时才可用，如果屏幕暗显，请先按任意按键使屏幕亮显再操作

## UC接收器 (UC RX)

功能介绍:

### 1. USB-C插头

插入手机USB-C插口即可使用



### 2. 输出音量调节按钮

短按可循环调节输出音量，A/B通道同步调节



### 3. 单声道和立体声切换按钮

短按可单声道和立体声切换。单通道模式下，立体声 (STEREO) 功能不可实现



#### 4. A/B通道状态指示灯

未配对时绿灯闪烁，配对成功后单声道蓝灯长亮，立体声绿灯长亮

A

B

#### 5. 3.5mm TRS/TRRS耳机监听插孔

插入3.5mm TRS/TRRS耳机即可监听



 UC版本不支持安全音轨模式



## 安装与使用方法

### 发射器 (TX)

1. 根据个人需求选择使用内置/外置麦克风

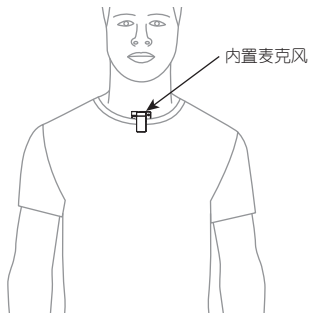

- 1. 在使用内置麦克风时，为了更好的隐蔽性，建议将背夹朝外固定使用
- 2. 当使用外置麦克风时，内置麦克风会自动关闭

## 接收器 (RX)

### 1. 模拟输出

通过3.5mm TRS-TRS音频连接线连接接收器和相机；通过3.5mm TRS-TRRS音频连接线搭配相关转接线连接接收器和手机/电脑，根据个人需求选择是否监听（转接线需自行购买）

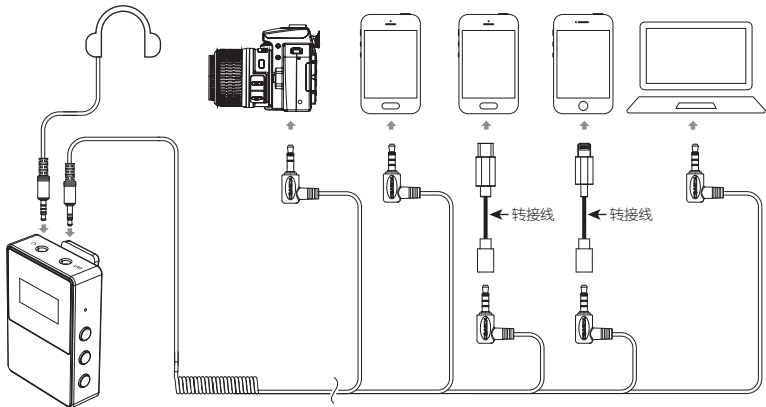

## 2. 数字输出

通过相关音频连接线搭配相关OTG音频转接线/转接头连接接收器和USB接口设备，根据个人需求选择是否监听

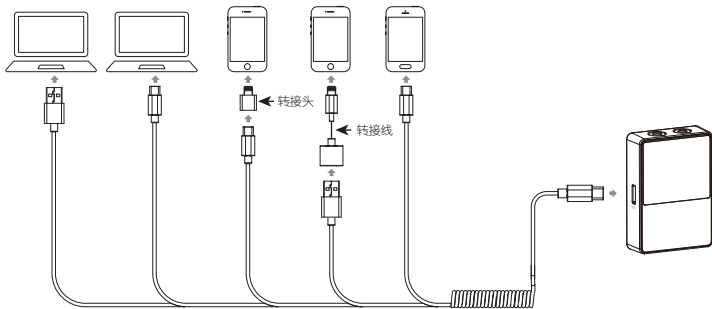

USB C-USB A音频连接线可用三合一充电/输出线中的橙色线，其他音频连接线及转接头需自行购买

## UC接收器 (UC RX)

把UC接收器 (UC RX) 插入手机的USB-C插口；把耳机插入3.5mm TRS/TRRS耳机监听插孔进行监听。

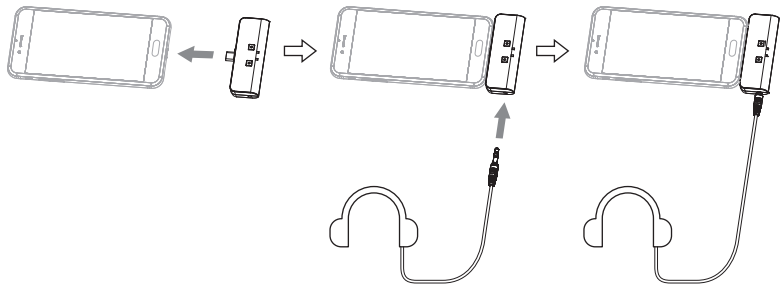

配对方法（出厂时均已配对，如需重新配对时可按如下描述操作）

BoomX-D的配对方法：

将发射器和接收器放置在一米范围内，分别长按电源键开机，再长按配对按键进入配对状态。此时发射器/接收器屏幕配对状态显示。配对成功后，对应通道图标显示**A/B**

发射器 (TX) 与接收器 (RX) 配对





发射器 (TX)



接收器 (RX)

## BoomX-D UC的配对方法：

将接收器连接至设备，接收器蓝灯闪烁，自动进入配对状态，长按发射器配对按键进入配对状态，发射器屏幕显示 ，配对成功后发射器屏幕显示 ，接收器指示灯长亮

发射器 (TX) 与UC接收器 (UC RX) 配对

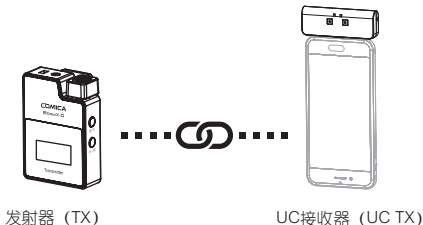

- 1. 发射器/接收器未配对时才能进入配对状态
- 2. 当有发射器未配对时，需将已配对的发射器先行关机，参考上述步骤将未配对的发射器与接收器配对，配对完成后再开启已配对的发射器使用

## 技术规格

### 发射器 (TX)

无线类型	2.4GHz
天线	陶瓷天线
发射功率	+10dBm
麦克风灵敏度	-32dB±2dB
麦克风指向性	全指向
麦克风频率响应	80Hz ~ 20kHz
系统信噪比	70dB SPL(A-weighted,as per IEC651)
系统等效噪声	24dB SPL(A-weighted,as per IEC651)
最大声压级	110dB SPL(@ 1% THD)
动态范围	86dB SPL(A-weighted,as per IEC651)
声音延迟	<20ms
外置输入接口	3.5mm TRS
电池	锂聚合物 330mAh 3.7V
续航时间	15小时
净重	29g
尺寸	39 x 22 x 55mm
工作温度	0℃ ~ 50℃
存储温度	-20℃ ~ +60℃

## 接收器 (RX)

无线类型	2.4GHz
天线	陶瓷天线
发射功率	+10dBm
系统信噪比	70dB SPL(A-weighted,as per IEC651)
系统等效噪声	24dB SPL(A-weighted,as per IEC651)
动态范围	86dB SPL(A-weighted,as per IEC651)
声音延迟	<20ms
输出调节范围	-6dB ~ +6dB
模拟输出	3.5mm TRS
数字输出	USB-C / 48kHz 16bits
监听接口	3.5mm TRS/TRRS
电池	锂聚合物 330mAh 3.7V
续航时间	12小时
净重	28g
尺寸	39 x 22 x 55mm
工作温度	0℃ ~ 50℃
存储温度	-20℃ ~ +60℃



## UC接收器 (UC RX)

无线类型	2.4GHz
天线	陶瓷天线
发射功率	+10dBm
音频输出挡位	1 ~ 4挡, 挡位步进6dB
系统信噪比	70dB SPL(A-weighted,as per IEC651)
系统等效噪声	24dB SPL(A-weighted,as per IEC651)
系统动态范围	86dB SPL(A-weighted,as per IEC651)
声音延迟	<20ms
数字接口	USB-C
监听接口	3.5mm TRS/TRRS
净重	15g
尺寸	33 x 13 x 70mm
工作温度	0℃ ~ 50℃
存储温度	-20℃ ~ 60℃







扫二维码关注  
科唛官方公众号



COMICA科唛



COMICA科唛



COMICA科唛



COMICA科唛

邮箱: [support@comica-audio.com](mailto:support@comica-audio.com)

电话: 400-8303-981

网址: [comica-audio.com](http://comica-audio.com)

版权及科唛商标归味莱科技有限公司所有